







クラッチ = 各車種専用につき写真とは異なる場合があります

① = Sメタル ディスク

② = オルガニック ディスク

③ = 純正タイプクラッチカバー

④ = Rメタル ディスク

⑤ = Rメタル専用 クラッチカバー

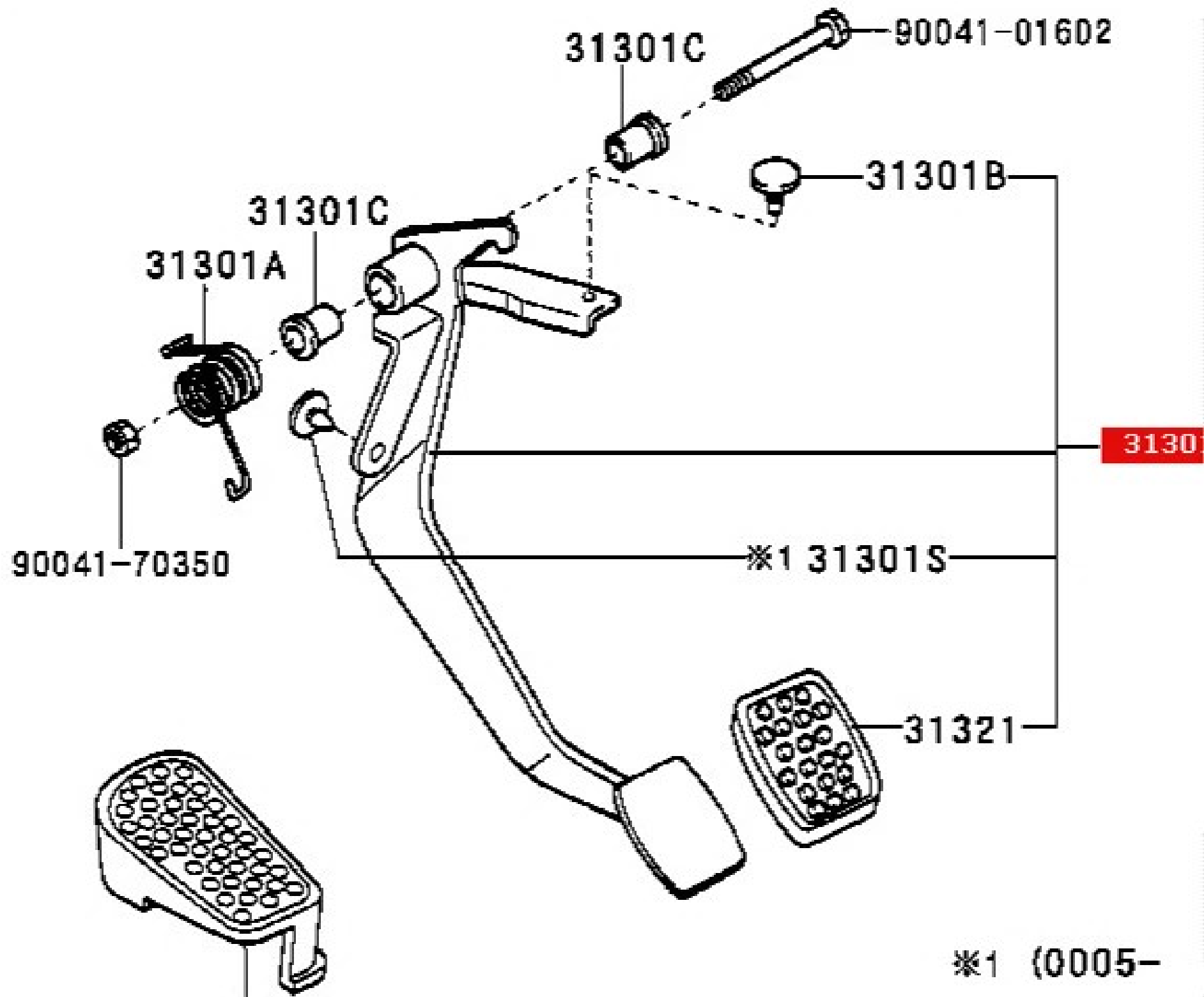



ОТВЕРСТИЕ КУДА ПРИКРУТИЛ ОСЬ ПЕДАЛИ СЦЕПЛЕНИЯ

ОТВЕРСТИЕ КУДА
НЕ ДОТЯГИВАЕТСЯ ПРУЖИНА
ПЕДАЛИ СЦЕПЛЕНИЯ



ОТВЕРСТИЕ КУДА ПРИКРУТИЛ ОСЬ ПЕДАЛИ СЦЕПЛЕНИЯ





ОТВЕРСТИЕ КУДА ПРИКРУТИЛ ОСЬ ПЕДАЛИ СЦЕПЛЕНИЯ





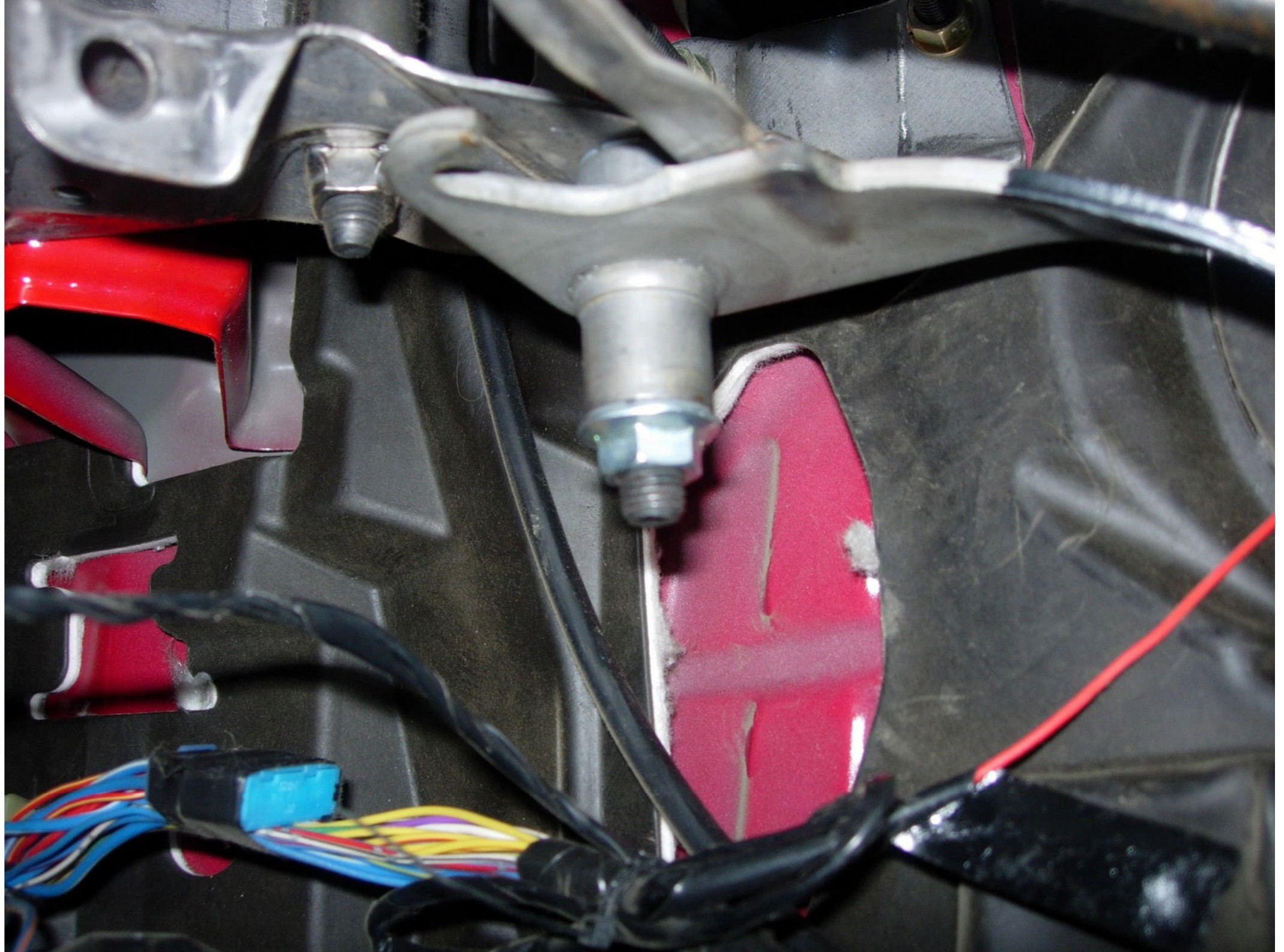





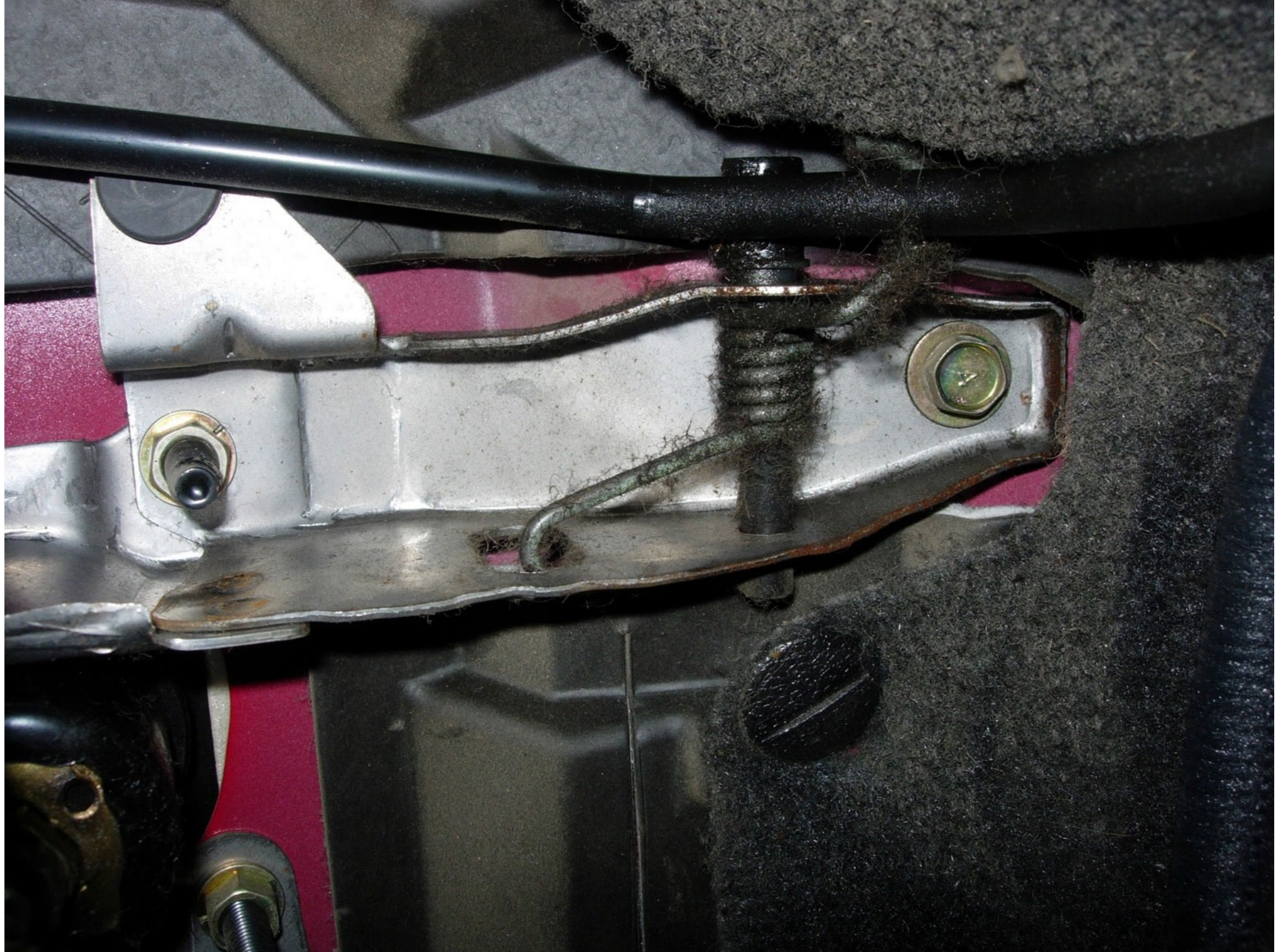

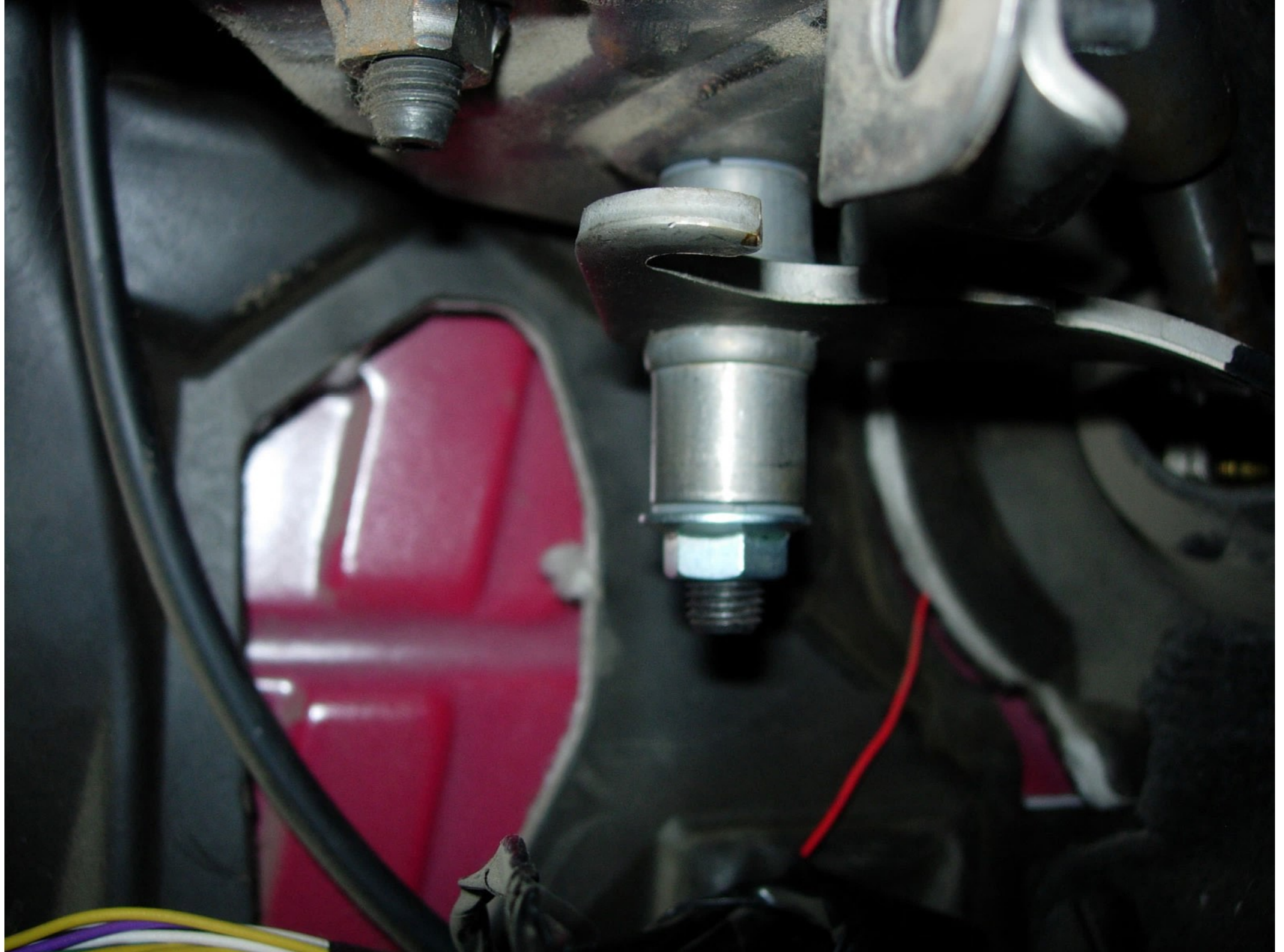





ICE
117600-0-1000

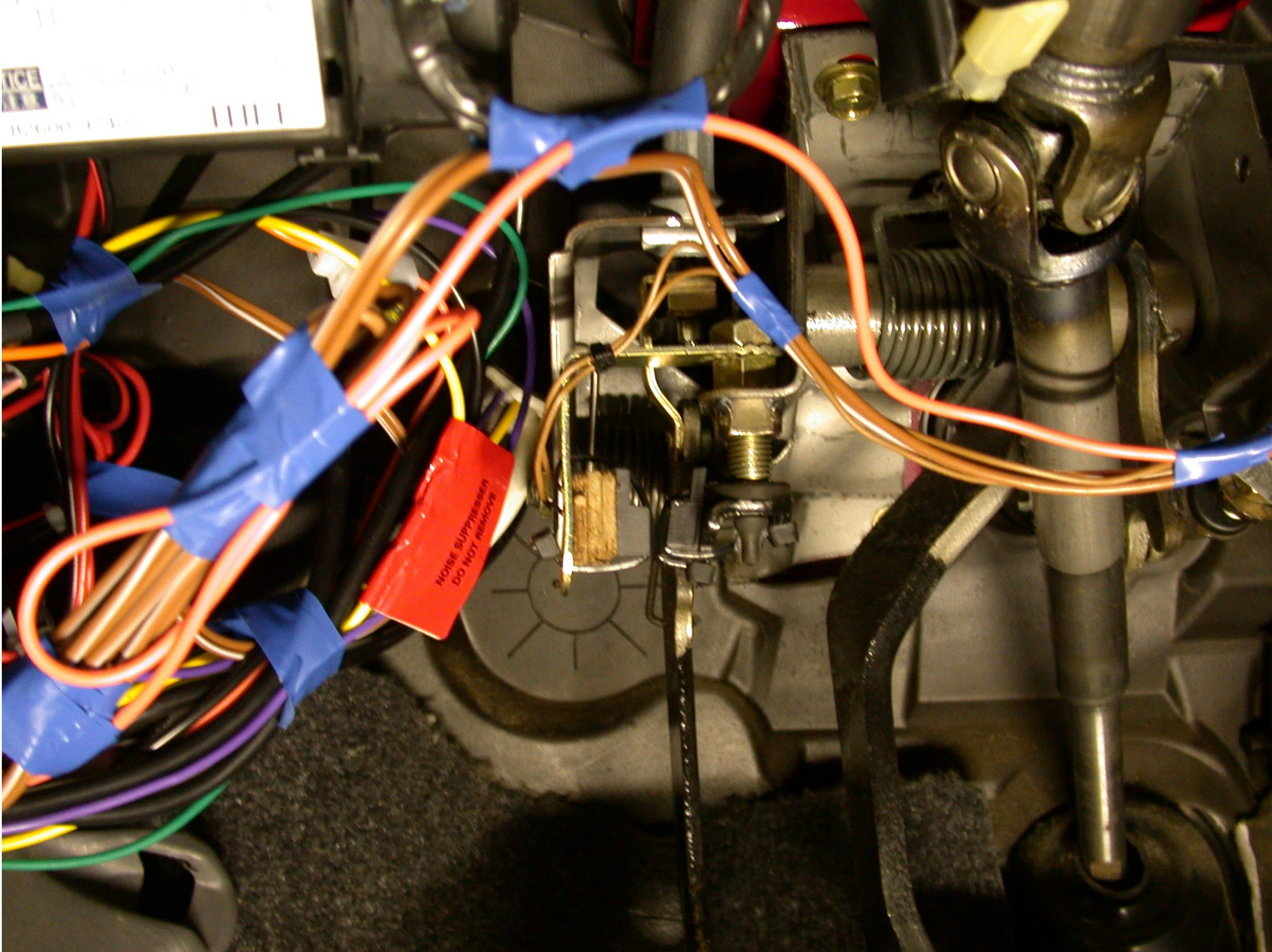

NOISE SUPPRESSOR
DO NOT REMOVE

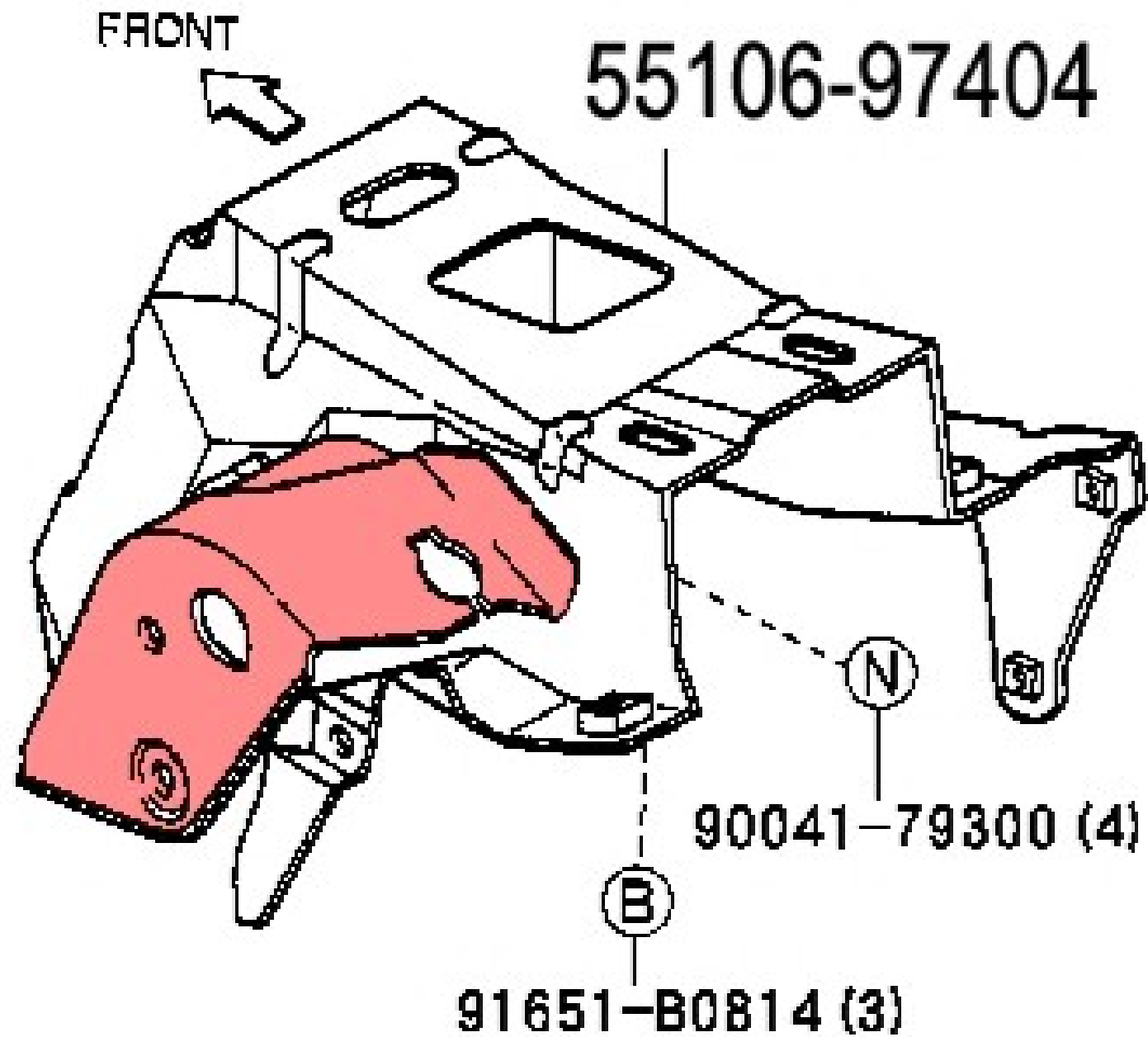

FRONT

55106-97404

N

90041-79300 (4)

B

91651-B0814 (3)

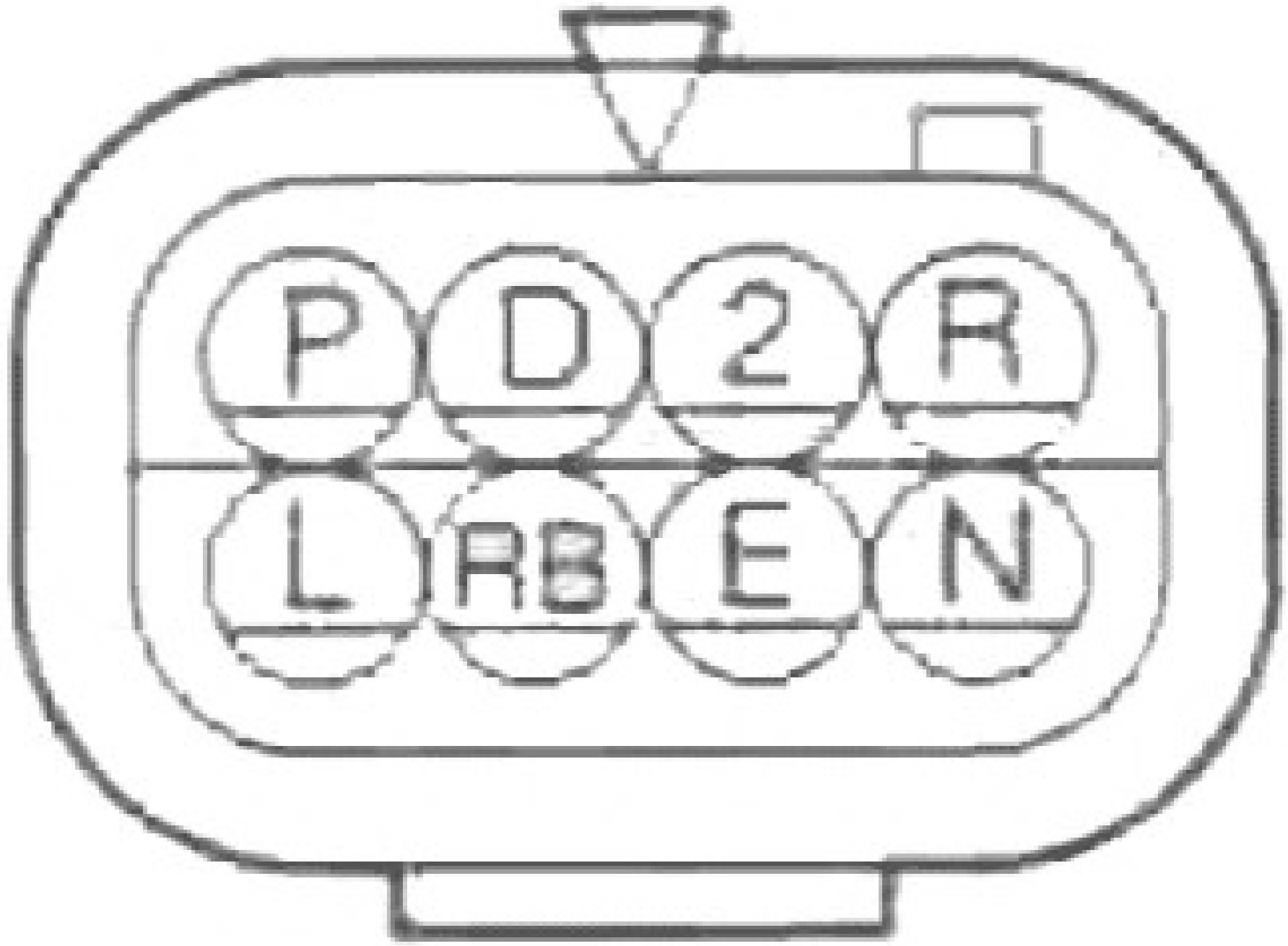

P D 2 R
L R E N



FALCON
CAM

55106-97404-1
20107
QR CODE

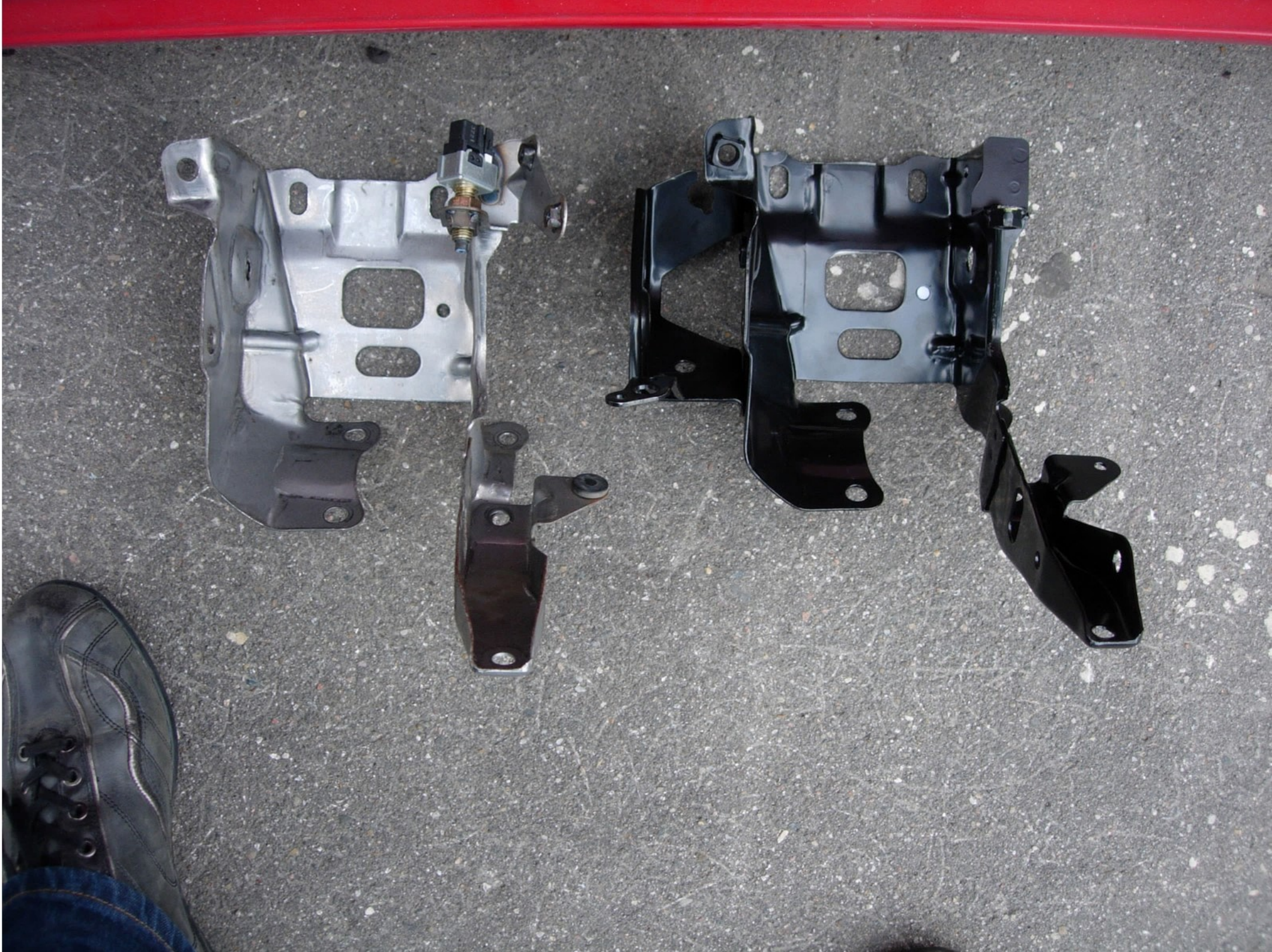







DSPORT

PART
NAME

クラッチディスク/メタル

PART NO.

31250
2100-C050

PRICE

税込 ¥26,250(本体)



8H08



DSPORT

PART
NAME

クラッチディスク/メタル

PART NO.

31250
2100-C050

PRICE

税込 ¥26,250(本体)



8H08



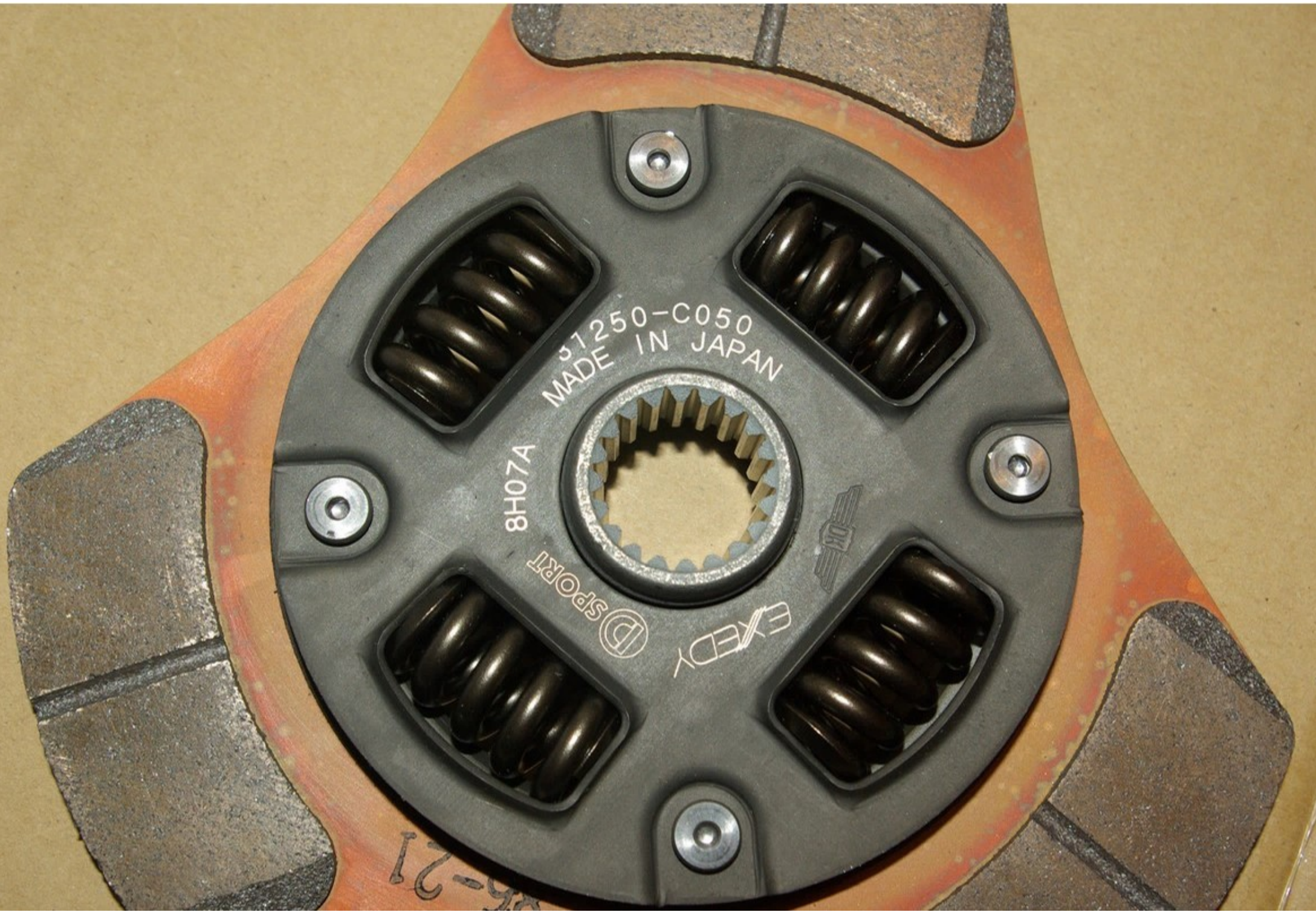

37250-C050
MADE IN JAPAN

8H07A

SPORT

EXEDY



21-25



8H07A

POINT

21